



## KR 240 R3200 PA arctic



### Technical data

Maximum reach	3195 mm
Rated payload	240 kg
Rated supplementary load, rotating column / link arm / arm	0 kg / 0 kg / 50 kg
Rated total load	-
Pose repeatability (ISO 9283)	± 0.06 mm
Number of axes	5
Mounting position	Floor
Footprint	830 mm x 830 mm
Weight	approx. 1103 kg

### Axis data

Motion range	
A1	±185 °
A2	-140 ° / -5 °
A3	0 ° / 155 °
A4	-
A5	-
A6	±350 °
Speed with rated payload	
A1	105 °/s
A2	101 °/s
A3	107 °/s
A4	-
A5	173 °/s
A6	242 °/s

### Operating conditions

Ambient temperature during operation: -30 °C to 10 °C (243 K to 283 K)

### Protection rating

Protection rating (IEC 60529)	IP65
Protection rating, in-line wrist (IEC 60529)	IP65

### Controller

Controller	KR C4
------------	-------

### Teach pendant

Teach pendant	KUKA smartPAD
---------------	---------------

### Workspace graphic

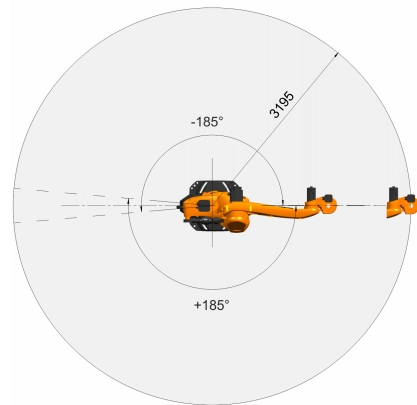
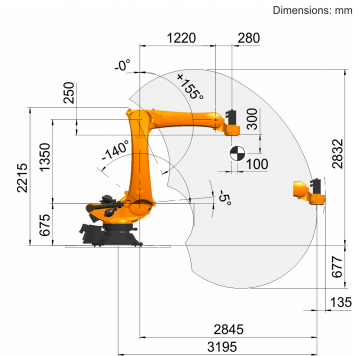

### Mounting flange

