

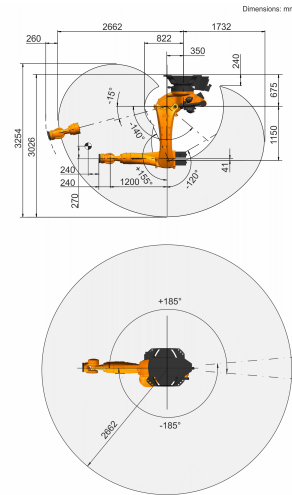

KR 270 R2700 ultra C-F



Workspace graphic



Technical data

Maximum reach	2662 mm
Rated payload	270 kg
Rated supplementary load, rotating column / link arm / arm	0 kg / 0 kg / 50 kg
Rated total load	320 kg
Pose repeatability (ISO 9283)	± 0.06 mm
Number of axes	6
Mounting position	Ceiling
Footprint	830 mm x 830 mm
Weight	approx. 1129 kg

Axis data

Motion range	
A1	±185 °
A2	-140 ° / -15 °
A3	-120 ° / 155 °
A4	±350 °
A5	±122.5 °
A6	±350 °
Speed with rated payload	
A1	105 °/s
A2	101 °/s
A3	107 °/s
A4	122 °/s
A5	113 °/s
A6	175 °/s

Mounting flange

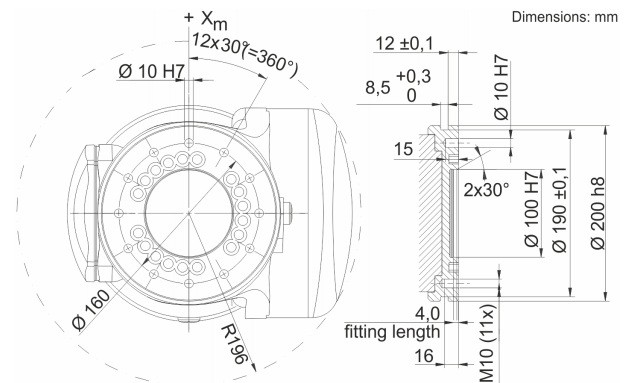

Operating conditions

Ambient temperature during operation: 10 °C to 55 °C (283 K to 328 K)

Protection rating

Protection rating (IEC 60529)	IP65
Protection rating, robot wrist (IEC 60529)	IP67

Controller

Controller	KR C4
------------	-------