



KR 240 R3200 PA-HO



Technical data

Maximum reach	3195 mm
Rated payload	240 kg
Rated supplementary load, rotating column / link arm / arm	0 kg / 0 kg / 50 kg
Rated total load	-
Pose repeatability (ISO 9283)	± 0.06 mm
Number of axes	5
Mounting position	Floor
Footprint	830 mm x 830 mm
Weight	approx. 1103 kg

Axis data

Motion range	
A1	±185 °
A2	-140 ° / -5 °
A3	0 ° / 155 °
A4	-
A5	-
A6	±350 °
Speed with rated payload	
A1	105 °/s
A2	101 °/s
A3	107 °/s
A4	-
A5	173 °/s
A6	242 °/s

Operating conditions

Ambient temperature during operation 0 °C to 55 °C (273 K to 328 K)

Protection rating

Protection rating (IEC 60529)	IP65
Protection rating, in-line wrist (IEC 60529)	IP65

Controller

Controller	KR C4
------------	-------

Teach pendant

Teach pendant	KUKA smartPAD
---------------	---------------

Workspace graphic

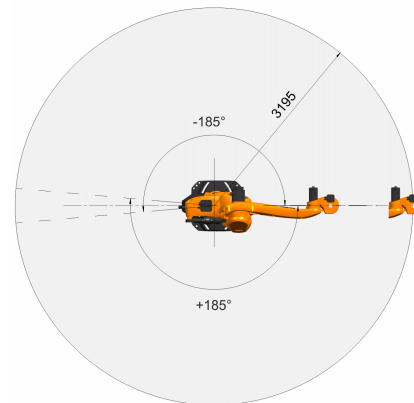
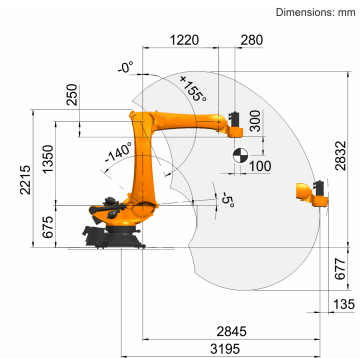

Mounting flange

