



KR 420 R3080 F



Technical data

Maximum reach	3076 mm
Maximum payload	526 kg
Rated payload	420 kg
Rated supplementary load, rotating column / link arm / arm	0 kg / 0 kg / 50 kg
Pose repeatability (ISO 9283)	± 0.08 mm
Number of axes	6
Mounting position	Floor
Footprint	1050 mm x 1050 mm
Weight	approx. 2415 kg

Axis data

Motion range	
A1	±185 °
A2	-130 ° / 20 °
A3	-100 ° / 144 °
A4	±350 °
A5	±120 °
A6	±350 °
Speed with rated payload	
A1	90 °/s
A2	80 °/s
A3	75 °/s
A4	90 °/s
A5	83 °/s
A6	130 °/s

Operating conditions

Ambient temperature during operation 10 °C to 55 °C (283 K to 328 K)

Protection rating

Protection rating (IEC 60529)	IP65
Protection rating, in-line wrist (IEC 60529)	IP67

Controller

Controller	KR C4
------------	-------

Teach pendant

Teach pendant	KUKA smartPAD
---------------	---------------

Workspace graphic

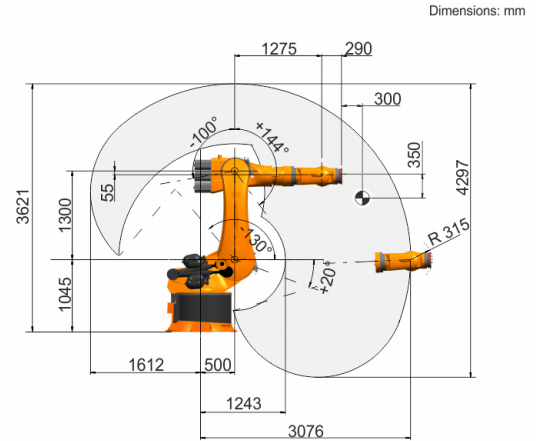

Payload diagram

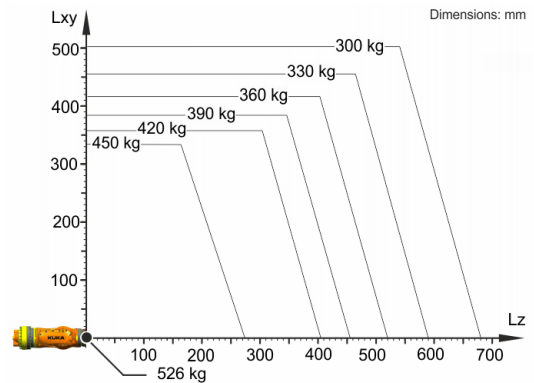

The KR 420 R3080 F is designed for a rated payload of 420 kg in order to optimize the dynamic performance of the robot. With reduced load center distances, higher loads up to the maximum payload may be used. The specific load case must be verified using KUKA.Load. For further consultation, please contact KUKA Support.

Mounting flange

