



## KR 6 R900 WP



### Technical data

Maximum reach	901.5 mm
Maximum payload	6 kg
Pose repeatability (ISO 9283)	± 0.03 mm
Number of axes	6
Mounting position	Floor; Ceiling; Wall; Desired angle
Footprint	320 mm x 320 mm
Weight	approx. 53 kg

### Axis data

Motion range	
A1	±170 °
A2	-190 ° / 45 °
A3	-120 ° / 156 °
A4	±185 °
A5	±120 °
A6	±350 °

### Operating conditions

Ambient temperature during operation	5 °C to 45 °C (278 K to 318 K)
--------------------------------------	--------------------------------

### Protection rating

Protection rating (IEC 60529)	IP67
Protection rating, robot wrist (IEC 60529)	IP67

### Controller

Controller	KR C5 micro; KR C4 compact
------------	-------------------------------

### Teach pendant

Teach pendant	KUKA smartPAD
---------------	---------------

### Cycle time

150 cycles per minute (25 mm / 305 mm / 25 mm, 1 kg)



### Workspace graphic

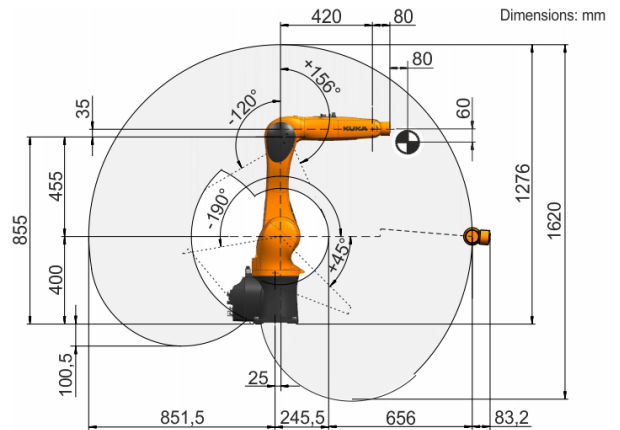

### Payload diagram

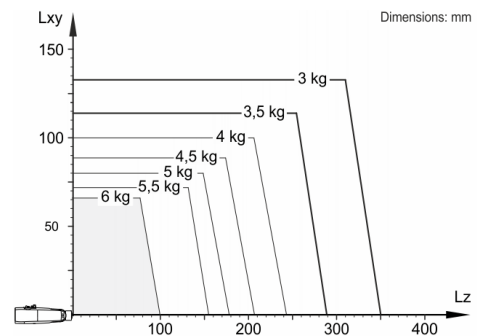

The KR 6 R900 WP is designed for a rated payload of 3 kg in order to optimize the dynamic performance of the robot. With reduced load center distances, higher loads up to the maximum payload may be used. The specific load case must be verified using KUKA.Load. For further consultation, please contact KUKA Support.

### Mounting flange

