



## KR 22 R1610-2



### Technical data

Maximum reach	1612 mm
Maximum payload	27.3 kg
Rated payload	22 kg
Rated supplementary load, rotating column / link arm / arm	0 kg / 0 kg / 10 kg
Pose repeatability (ISO 9283)	± 0.04 mm
Number of axes	6
Mounting position	Floor; Ceiling; Wall; Desired angle
Footprint	430.5 mm x 370 mm
Weight	approx. 255 kg

### Axis data

Motion range	
A1	±185 °
A2	-185 ° / 65 °
A3	-138 ° / 175 °
A4	±350 °
A5	±130 °
A6	±350 °
Speed with rated payload	
A1	200 °/s
A2	175 °/s
A3	190 °/s
A4	430 °/s
A5	430 °/s
A6	630 °/s

### Operating conditions

Ambient temperature during operation	5 °C to 55 °C (278 K to 328 K)
--------------------------------------	--------------------------------

### Protection rating

Protection rating (IEC 60529)	IP65
Protection rating, robot wrist (IEC 60529)	IP65

### Controller

Controller	KR C4
------------	-------

### Certificates

ESD requirements	IEC61340-5-1; ANSI/ESD S20.20
------------------	-------------------------------

### Teach pendant

Teach pendant	KUKA smartPAD-2
---------------	-----------------

### Workspace graphic

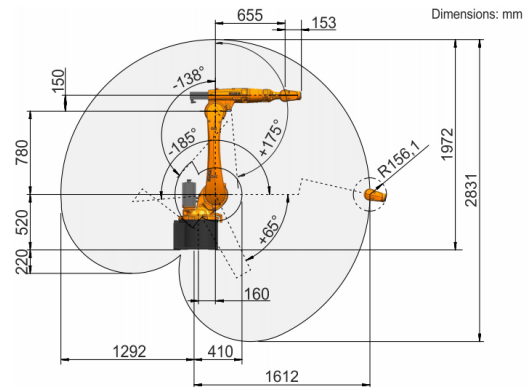

### Payload diagram

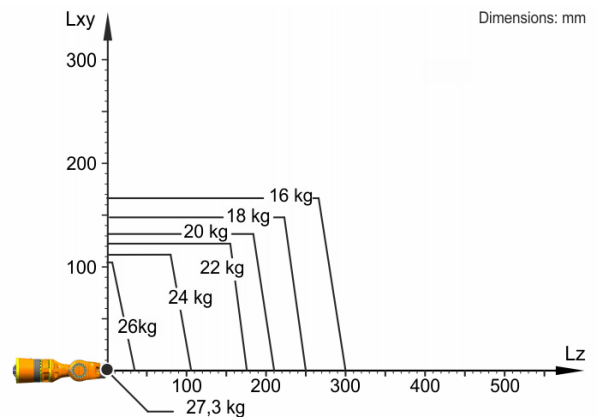

The KR 22 R1610-2 is designed for a rated payload of 22 kg in order to optimize the dynamic performance of the robot. With reduced load center distances, higher loads up to the maximum payload may be used. The specific load case must be verified using KUKA.Load. For further consultation, please contact KUKA Support.

### Mounting flange

