



KR 150 R2700-2



Technical data

Maximum reach	2701 mm
Maximum payload	218 kg
Rated payload	150 kg
Rated supplementary load, rotating column / link arm / arm	0 kg / 0 kg / 50 kg
Pose repeatability (ISO 9283)	± 0.05 mm
Number of axes	6
Mounting position	Floor
Footprint	754 mm x 754 mm
Weight	approx. 1072 kg

Axis data

Motion range	
A1	±185 °
A2	-140 ° / -5 °
A3	-120 ° / 168 °
A4	±350 °
A5	±125 °
A6	±350 °
Speed with rated payload	
A1	120 °/s
A2	115 °/s
A3	120 °/s
A4	190 °/s
A5	180 °/s
A6	260 °/s

Operating conditions

Ambient temperature during operation	0 °C to 55 °C (273 K to 328 K)
--------------------------------------	--------------------------------

Protection rating

Protection rating (IEC 60529)	IP65
Protection rating, in-line wrist (IEC 60529)	IP65 / IP67

Controller

Controller	KR C5; KR C4
------------	-----------------

Certificates

ESD requirements	IEC61340-5-1; ANSI/ESD S20.20
------------------	-------------------------------

Teach pendant

Teach pendant	KUKA smartPAD-2
---------------	-----------------

Workspace graphic

Dimensions: mm

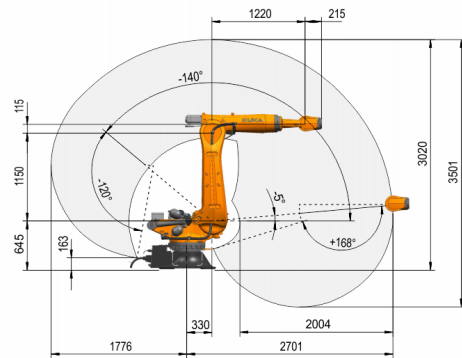

Payload diagram

Dimensions: mm

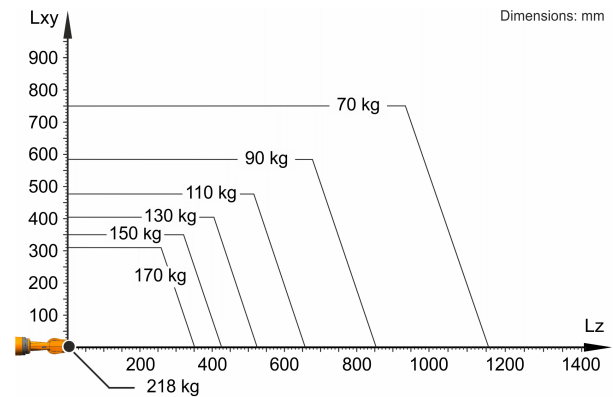

The KR 150 R2700-2 is designed for a rated payload of 150 kg in order to optimize the dynamic performance of the robot. With reduced load center distances, higher loads up to the maximum payload may be used. The specific load case must be verified using KUKA.Load. For further consultation, please contact KUKA Support.

Mounting flange

Dimensions: mm

