



KR 70 R2100



Technical data

Maximum reach	2101 mm
Maximum payload	85 kg
Rated payload	70 kg
Rated supplementary load, rotating column / link arm / arm	0 kg / 0 kg / 20 kg
Pose repeatability (ISO 9283)	± 0.05 mm
Number of axes	6
Mounting position	Floor; Ceiling; Wall; Desired angle
Footprint	603 mm x 480 mm
Weight	approx. 536 kg

Axis data

Motion range	
A1	±185 °
A2	-175 ° / 60 °
A3	-120 ° / 165 °
A4	±180 °
A5	±125 °
A6	±350 °
Speed with rated payload	
A1	180 °/s
A2	158 °/s
A3	160 °/s
A4	230 °/s
A5	230 °/s
A6	320 °/s

Operating conditions

Ambient temperature during operation	0 °C to 55 °C (273 K to 328 K)
--------------------------------------	--------------------------------

Protection rating

Protection rating (IEC 60529)	IP65
Schutzart Arm (IEC 60529)	IP65 / IP67
Protection rating, in-line wrist (IEC 60529)	IP65 / IP67

Controller

Controller	KR C4
------------	-------

Certificates

ESD requirements	IEC61340-5-1; ANSI/ESD S20.20
------------------	-------------------------------

Teach pendant

Teach pendant	KUKA smartPAD
---------------	---------------

Workspace graphic

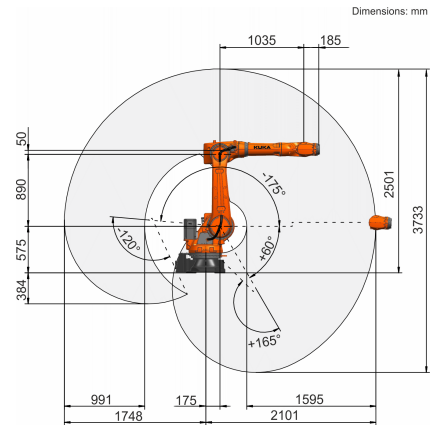

Payload diagram

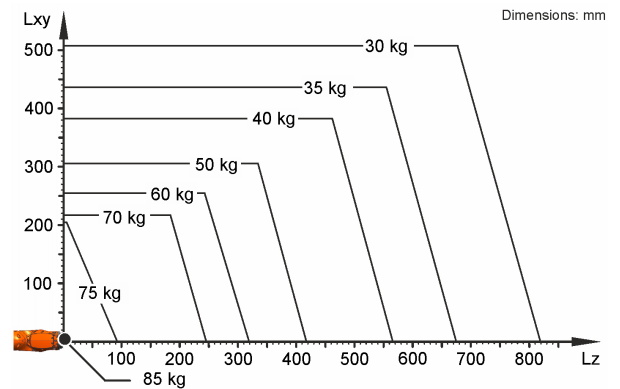

The KR 70 R2100 is designed for a rated payload of 70 kg in order to optimize the dynamic performance of the robot. With reduced load center distances, higher loads up to the maximum payload may be used. The specific load case must be verified using KUKA.Load. For further consultation, please contact KUKA Support.

Mounting flange

