



KR 140 R3200-2 PA



Technical data

Maximum reach	3195 mm
Rated payload	140 kg
Maximum payload	180 kg
Maximum supplementary load, rotating column / link arm / arm	300 kg / 130 kg / 150 kg
Pose repeatability (ISO 9283)	± 0.07 mm
Number of axes	5
Mounting position	Floor
Footprint	754 mm x 754 mm
Weight	approx. 1017 kg

Axis data

Motion range	
A1	±185 °
A2	-140 ° / -5 °
A3	0 ° / 165 °
A4	-
A5	-55 ° / 150 °
A6	±350 °
Speed with rated payload	
A1	137 °/s
A2	111 °/s
A3	119 °/s
A4	-
A5	225 °/s
A6	321 °/s

Operating conditions

Ambient temperature during operation	0 °C to 55 °C (273 K to 328 K)
--------------------------------------	--------------------------------

Protection rating

Protection rating (IEC 60529)	IP65
Protection rating, robot wrist (IEC 60529)	IP65

Controller

Controller	KR C5
------------	-------

Workspace graphic

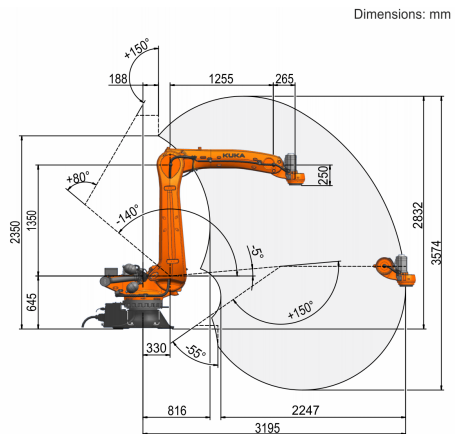

Payload diagram

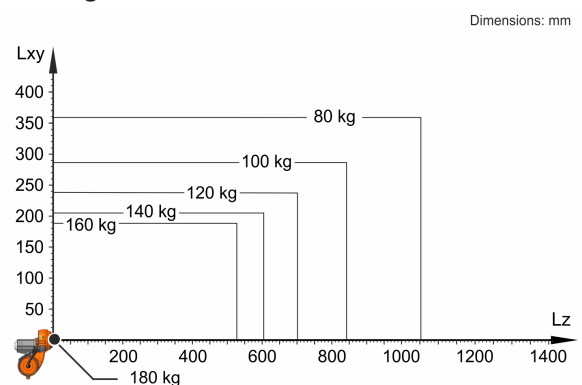

The KR 140 R3200-2 PA is designed for a rated payload of 140 kg in order to optimize the dynamic performance of the robot. The maximum payload of 180 kg applies only if the position of the center of mass is 0 mm and a supplementary load optimized for the load case is mounted. The specific load case must be verified using KUKA.Load or KUKA Compose. For further consultation, please contact KUKA Support.

Mounting flange

