



KR 240 R3330 F



Technical data

Maximum reach	3326 mm
Rated payload	240 kg
Maximum payload	297 kg
Maximum supplementary load, rotating column / link arm / arm	-
Pose repeatability (ISO 9283)	± 0.08 mm
Number of axes	6
Mounting position	Floor
Footprint	1050 mm x 1050 mm
Weight	approx. 2421 kg

Axis data

Motion range	
A1	±185 °
A2	-130 ° / 20 °
A3	-100 ° / 144 °
A4	±350 °
A5	±120 °
A6	±350 °
Speed with rated payload	
A1	100 °/s
A2	90 °/s
A3	90 °/s
A4	120 °/s
A5	110 °/s
A6	160 °/s

Operating conditions

Ambient temperature during operation	10 °C to 55 °C (283 K to 328 K)
--------------------------------------	---------------------------------

Protection rating

Protection rating (IEC 60529)	IP65
Protection rating, robot wrist (IEC 60529)	IP67

Controller

Controller	KR C5; KR C4
------------	-----------------

Workspace graphic

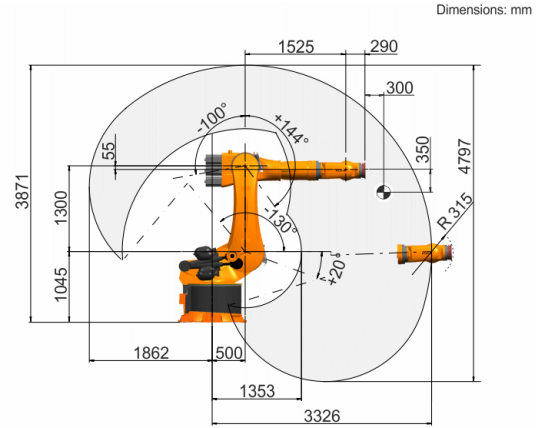

Payload diagram

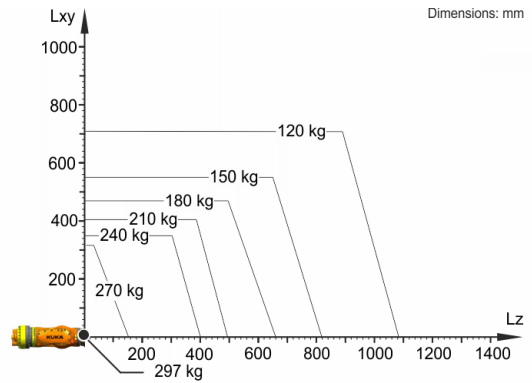

The KR 240 R3330 F is designed for a rated payload of 240 kg in order to optimize the dynamic performance of the robot. The maximum payload of 297 kg applies only if the position of the center of mass is 0 mm and a supplementary load optimized for the load case is mounted. The specific load case must be verified using KUKA.Load or KUKA Compose. For further consultation, please contact KUKA Support.

Mounting flange

