



## KR 210 R2700-2



### Technical data

Maximum reach	2701 mm
Rated payload	210 kg
Maximum payload	275 kg
Maximum supplementary load, rotating column / link arm / arm	300 kg / 130 kg / 150 kg
Pose repeatability (ISO 9283)	± 0.05 mm
Number of axes	6
Mounting position	Floor
Footprint	754 mm x 754 mm
Weight	approx. 1077 kg

### Axis data

Motion range	
A1	±185 °
A2	-140 ° / -5 °
A3	-120 ° / 168 °
A4	±350 °
A5	±125 °
A6	±350 °
Speed with rated payload	
A1	120 °/s
A2	115 °/s
A3	112 °/s
A4	179 °/s
A5	172 °/s
A6	220 °/s

### Operating conditions

Ambient temperature during operation	0 °C to 55 °C (273 K to 328 K)
--------------------------------------	--------------------------------

### Protection rating

Protection rating (IEC 60529)	IP65
Protection rating, robot wrist (IEC 60529)	IP65 / IP67

### Controller

Controller	KR C5; KR C4
------------	-----------------

### Certificates

ESD requirements	IEC61340-5-1; ANSI/ESD S20.20
------------------	-------------------------------

### Workspace graphic

Dimensions: mm

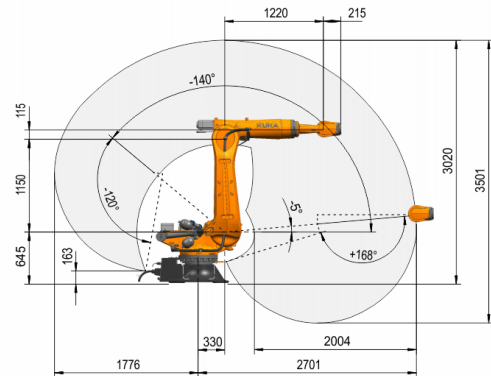

### Payload diagram

Dimensions: mm

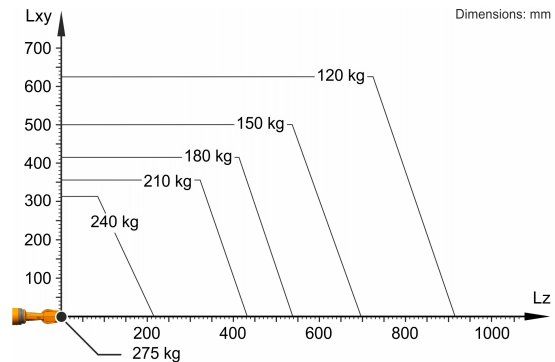

The KR 210 R2700-2 is designed for a rated payload of 210 kg in order to optimize the dynamic performance of the robot. The maximum payload of 275 kg applies only if the position of the center of mass is 0 mm and a supplementary load optimized for the load case is mounted. The specific load case must be verified using KUKA.Load or KUKA Compose. For further consultation, please contact KUKA Support.

### Mounting flange

Dimensions: mm

