



KR 6 R1840-2



Technical data

Maximum reach	1840 mm
Rated payload	6 kg
Maximum payload	9 kg
Maximum supplementary load, rotating column / link arm / arm	-
Pose repeatability (ISO 9283)	± 0.04 mm
Number of axes	6
Mounting position	Floor; Ceiling; Wall; Desired angle
Footprint	333.5 mm x 307 mm
Weight	approx. 162 kg

Axis data

Motion range	
A1	±170 °
A2	-185 ° / 65 °
A3	-137 ° / 163 °
A4	±185 °
A5	±120 °
A6	±350 °
Speed with rated payload	
A1	220 °/s
A2	210 °/s
A3	270 °/s
A4	381 °/s
A5	311 °/s
A6	472 °/s

Operating conditions

Ambient temperature during operation	0 °C to 55 °C (273 K to 328 K)
Cleanroom class (ISO 14644-1)	Class 5 at 40% override; Class 5 at 80% override

Protection rating

Protection rating (IEC 60529)	IP65
Protection rating, robot wrist (IEC 60529)	IP67

Controller

Controller	KR C5
------------	-------

Certificates

ESD requirements	IEC61340-5-1; ANSI/ESD S20.20
------------------	-------------------------------

Workspace graphic

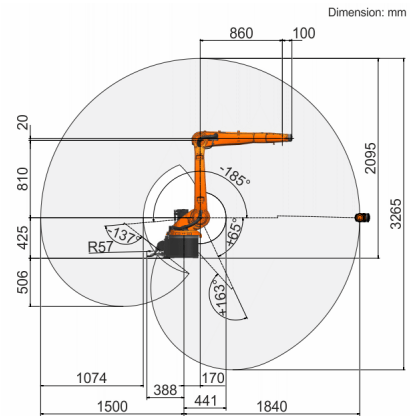

Payload diagram

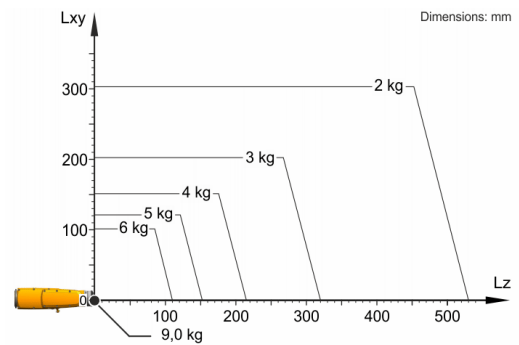

The KR 6 R1840-2 is designed for a rated payload of 6 kg in order to optimize the dynamic performance of the robot. The maximum payload of 9 kg applies only if the position of the center of mass is 0 mm and a supplementary load optimized for the load case is mounted. The specific load case must be verified using KUKA.Load or KUKA Compose. For further consultation, please contact KUKA Support.

Mounting flange

