



## KR 70 R2100 F



### Technical data

Maximum reach	2101 mm
Rated payload	70 kg
Maximum payload	85 kg
Maximum supplementary load, rotating column / link arm / arm	50 kg / 30 kg / 30 kg
Pose repeatability (ISO 9283)	± 0.05 mm
Number of axes	6
Mounting position	Floor; Ceiling; Wall; Desired angle
Footprint	603 mm x 480 mm
Weight	approx. 536 kg

### Axis data

Motion range	
A1	±185 °
A2	-175 ° / 60 °
A3	-120 ° / 165 °
A4	±180 °
A5	±125 °
A6	±350 °
Speed with rated payload	
A1	180 °/s
A2	158 °/s
A3	160 °/s
A4	230 °/s
A5	230 °/s
A6	320 °/s

### Operating conditions

Ambient temperature during operation	0 °C to 55 °C (273 K to 328 K)
--------------------------------------	--------------------------------

### Protection rating

Protection rating (IEC 60529)	IP65 / IP67
Schutzart Arm (IEC 60529)	IP65 / IP67
Protection rating, robot wrist (IEC 60529)	IP65 / IP67

### Controller

Controller	KR C5; KR C4
------------	-----------------

### Workspace graphic

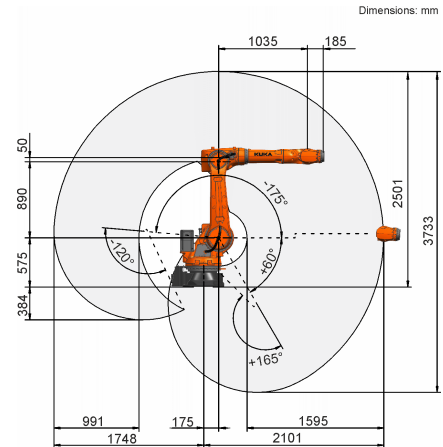

### Payload diagram

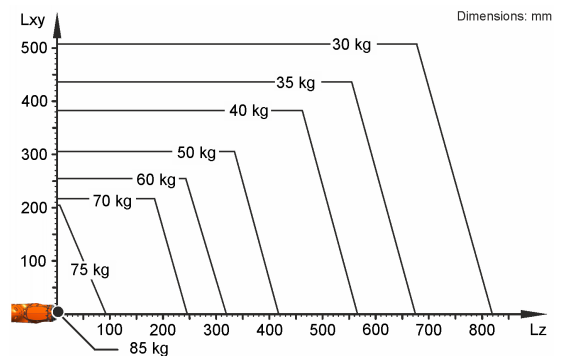

The KR 70 R2100 F is designed for a rated payload of 70 kg in order to optimize the dynamic performance of the robot. With reduced load center distances and favorable supplementary loads, a maximum payload of up to 85 kg can be mounted. The specific KUKA Load case must be verified using KUKA. For further consultation, please contact KUKA Service.

### Mounting flange

