



KR 20 R800 Z390 CR



Designation	KR 20 R800 Z390 CR
Number of axes	4
Pose repeatability XY	± 0.025 mm
Pose repeatability Z	± 0.01 mm
Pose repeatability R	± 0.01 °
Weight	approx. 63 kg
Rated payload	10 kg
Maximum payload	20 kg
Maximum reach	800 mm
Mounting position	Floor
Footprint	230 mm x 235 mm

Axis data

Motion range	
Motion range, axis 1	±140 °
Motion range, axis 2	±140 °
Motion range, axis 3	-390 mm / 1 mm
Motion range, axis 4	±355 °
Speed with rated payload	
Axis velocity, axis 1	400 °/s
Axis velocity, axis 2	570 °/s
Axis velocity, axis 3	1.1 m/s
Axis velocity, axis 4	1400 °/s

Operating conditions

Ambient temperature during operation	0 °C to 45 °C (273 K to 318 K)
Cleanroom class (ISO 14644-1)	Class 5 at 100% override

Protection rating

Protection rating (IEC 60529)	IP54
-------------------------------	------

Controller

Controller	KR C5 micro
------------	-------------

Certificates

ESD requirements	IEC61340-5-1; ANSI/ESD S20.20
Certificates	CE/UL

Workspace graphic

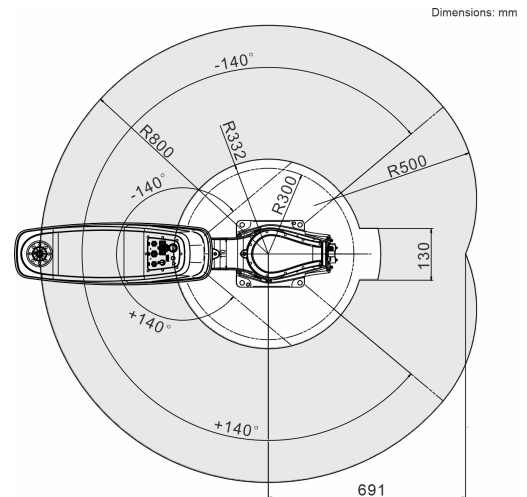

Payload diagram

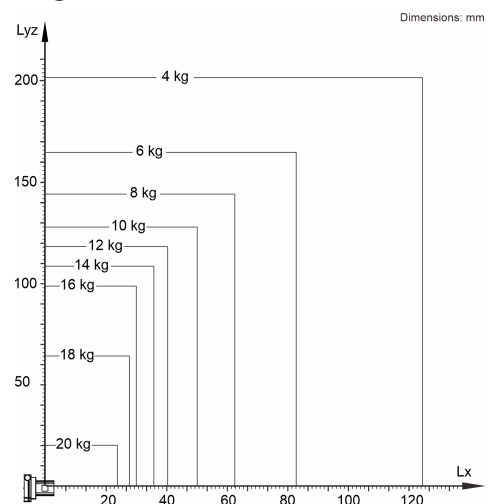

The KR 20 R800 Z390 CR is designed for a rated payload of 10 kg in order to optimize the dynamic performance of the manipulator. With the reduced load center distances, higher loads up to the maximum payload may be used. The specific load case must be verified using KUKA.Load. For further consultation, please contact KUKA Support.

Cycle time

133 cycles per minute (25 mm / 300 mm / 25 mm, 2 kg)

