



KR 12 R1810-2



Technical data

Maximum reach	1813 mm
Rated payload	12 kg
Maximum payload	14.5 kg
Maximum supplementary load, rotating column / link arm / arm	20 kg / 15 kg / 15 kg
Pose repeatability (ISO 9283)	± 0.04 mm
Number of axes	6
Mounting position	Floor; Ceiling; Wall; Desired angle
Footprint	430.5 mm x 370 mm
Weight	approx. 255 kg

Axis data

Motion range	
A1	±185 °
A2	-185 ° / 65 °
A3	-138 ° / 175 °
A4	±350 °
A5	±130 °
A6	±350 °
Speed with rated payload	
A1	200 °/s
A2	175 °/s
A3	190 °/s
A4	430 °/s
A5	430 °/s
A6	630 °/s

Operating conditions

Ambient temperature during operation	5 °C to 55 °C (278 K to 328 K)
--------------------------------------	--------------------------------

Protection rating

Protection rating (IEC 60529)	IP65
Protection rating, robot wrist (IEC 60529)	IP65

Controller

Controller	KR C5; KR C4
------------	-----------------

Certificates

ESD requirements	IEC61340-5-1; ANSI/ESD S20.20
------------------	-------------------------------

Workspace graphic

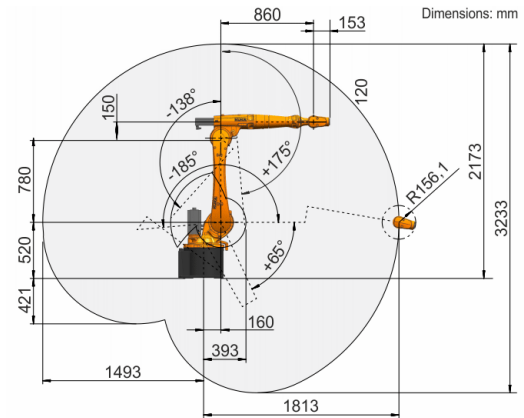

Payload diagram

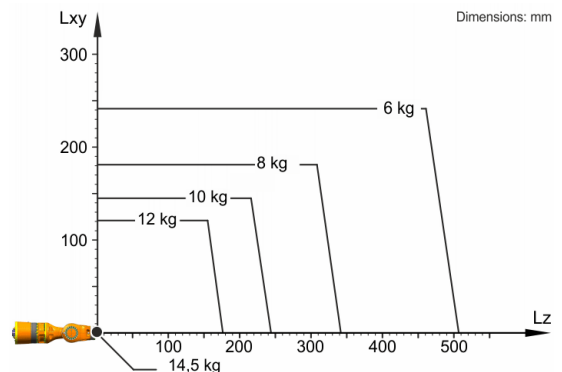

The KR 12 R1810-2 is designed for a rated payload of 12 kg in order to optimize the dynamic performance of the robot. The maximum payload of 14.5 kg applies only if the position of the center of mass is 0 mm and a supplementary load optimized for the load case is mounted. The specific load case must be verified using KUKA.Load or KUKA Compose. For further consultation, please contact KUKA Support.

Mounting flange

